

k.
KASPA

40610102

REA GOLD

INSTRUKCJA

MONTAŻU I OBSŁUGI



MAX 25W LED E27



1 x

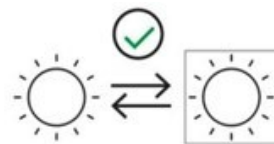

1

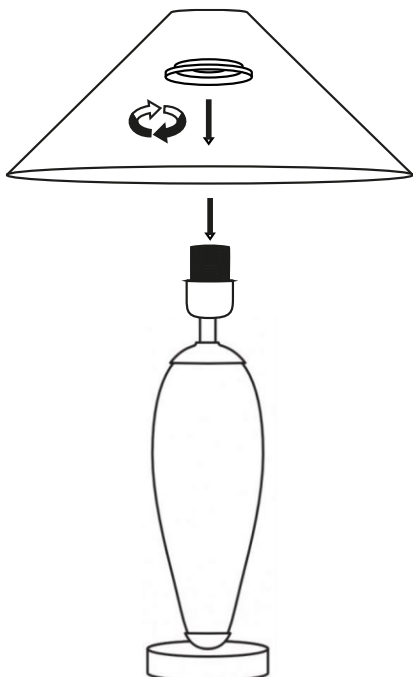

2

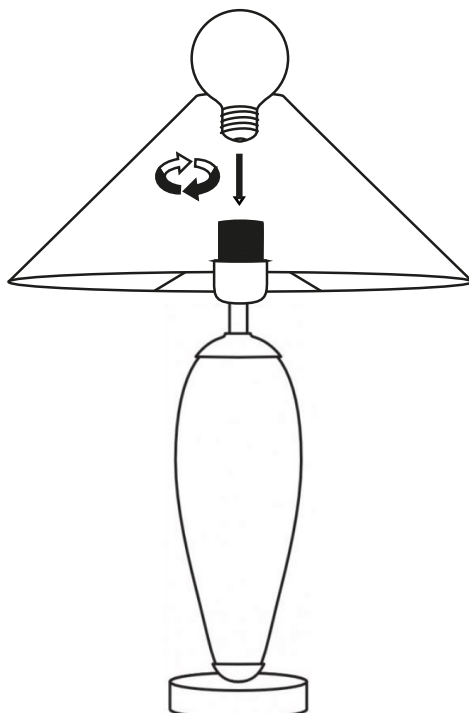

3

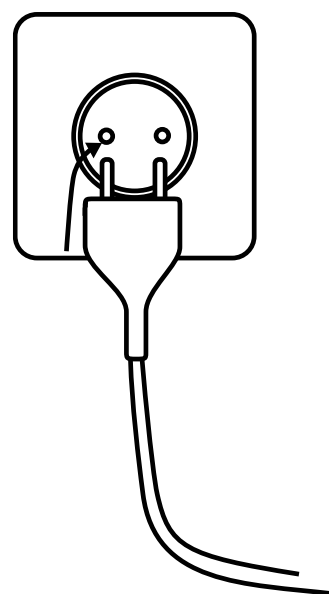

W RAZIE PROBLEMÓW CZY PYTAŃ

kom: 662 239 365

mail: biuro@kasper.com.pl

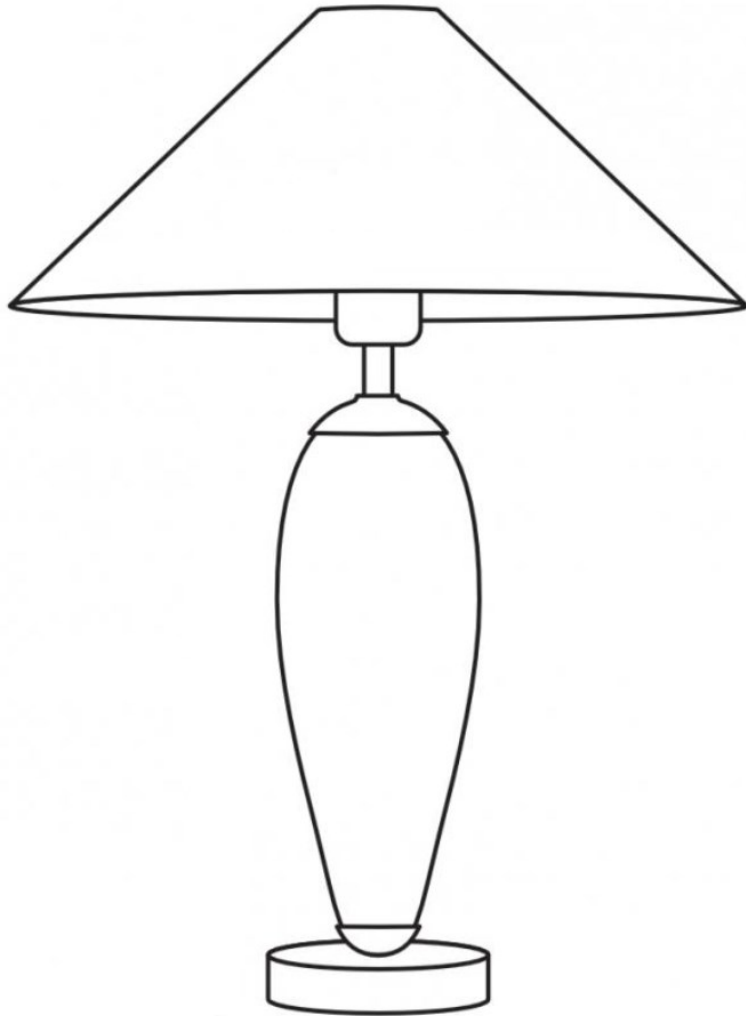

k.
KASPA

40610102

REA GOLD

INSTRUCTION

MANUAL



MAX 25W LED E27



1 x

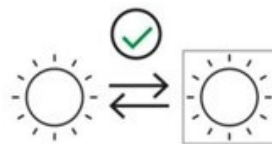

1

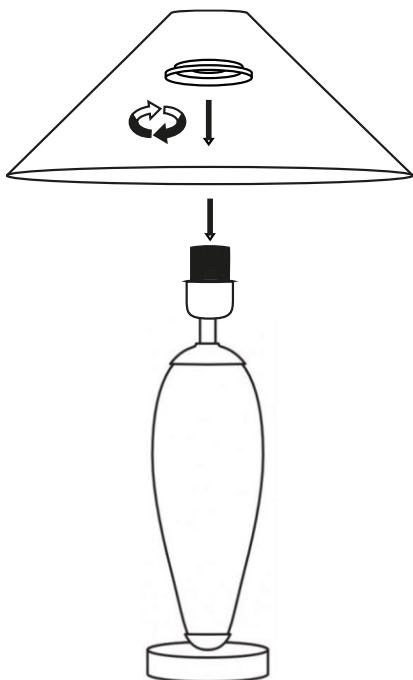

2

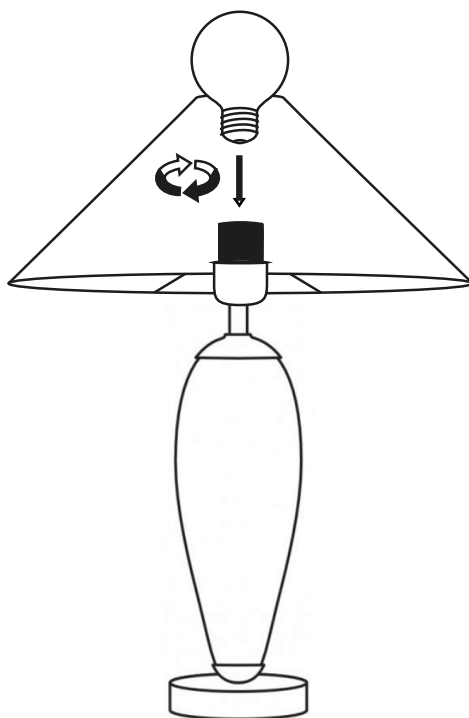

3

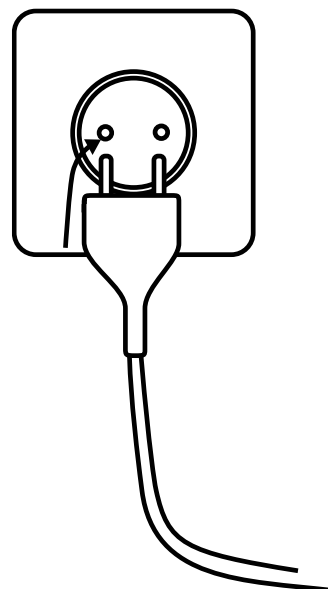

IN CASE OF PROBLEMS OR QUESTIONS

mail: biuro@kasper.com.pl