

**k.**  
KASPA

41093107

---

ZOE

INSTRUKCJA

---

MONTAŻU I OBSŁUGI



MAX 25W LED E27



1 x



1

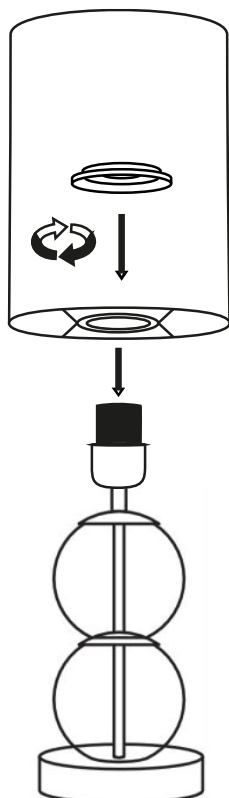

2

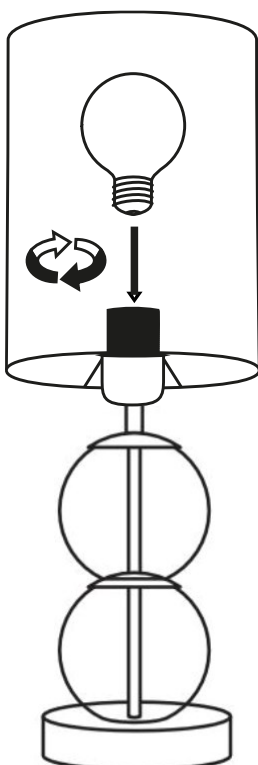

3

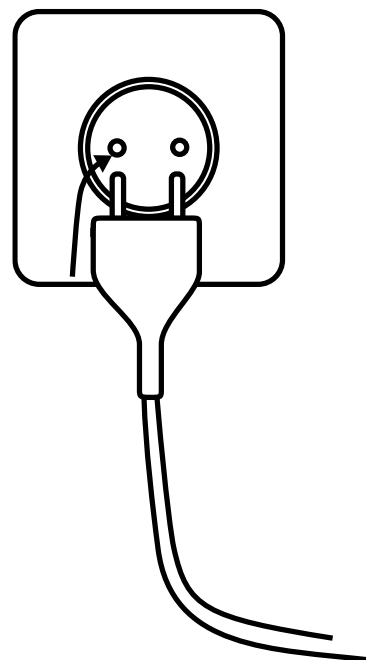

**W RAZIE PROBLEMÓW CZY PYTAŃ**

kom: 662 239 365

mail: [biuro@kaspacom.pl](mailto:biuro@kaspacom.pl)

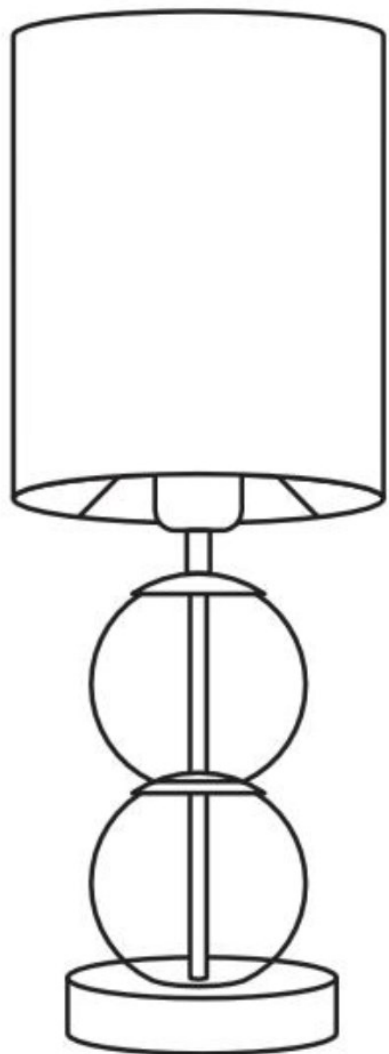

**k.**  
KASPA

41093107

---

ZOE

INSTRUCTION

---

MANUAL



MAX 25W LED E27



1 x

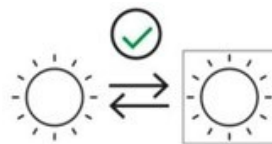

1

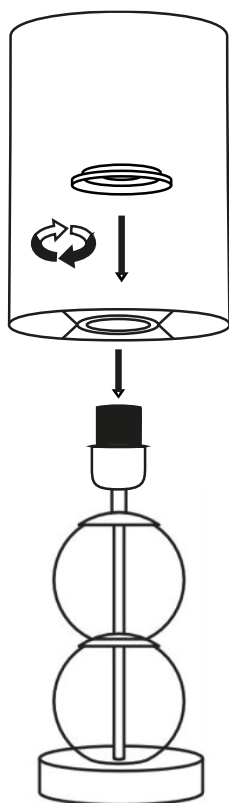

2

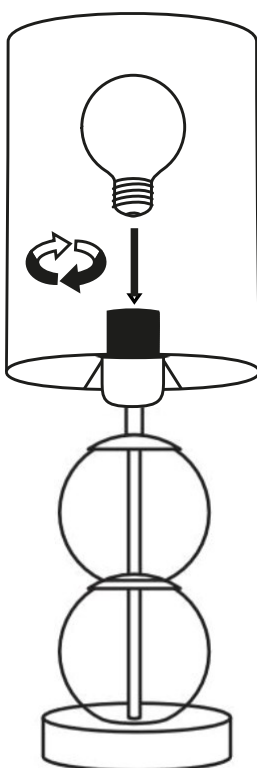

3

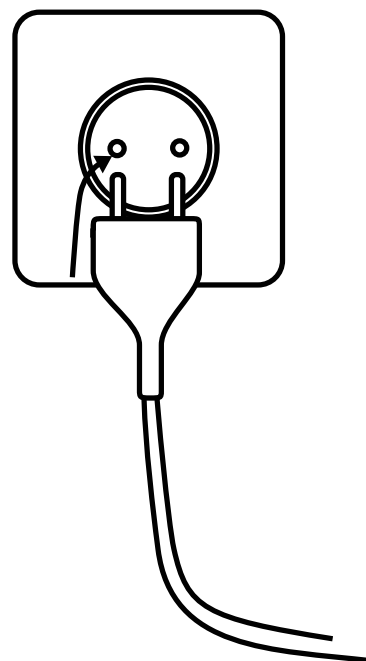

**IN CASE OF PROBLEMS OR QUESTIONS**

mail: [biuro@kaspacom.pl](mailto:biuro@kaspacom.pl)