

**k.**  
**KASPA**  
BY DESIGNERS

41234113

---

**APOLIN LAMPA  
PRZENOŚNA**

**INSTRUKCJA**

---

**MONTAŻU I OBSŁUGI**

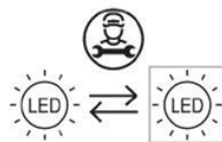

ZMIANA MOCY  
ŚWIATŁA

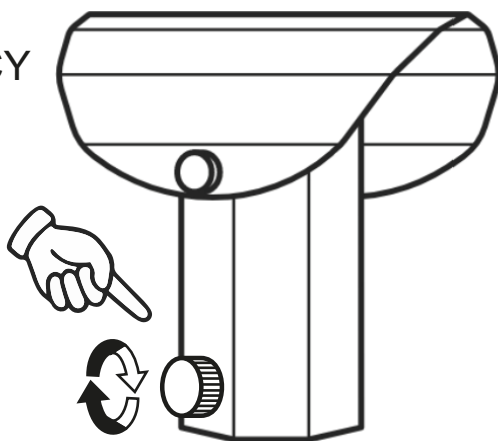
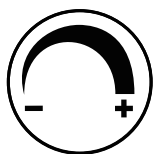

BRAK ŁADOWARKI  
W ZESTAWIE

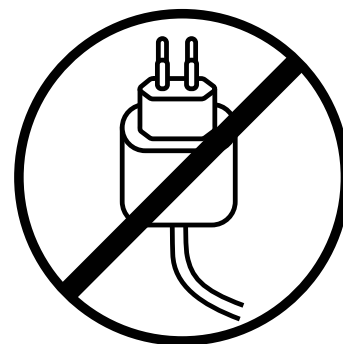

ŁADOWANIE  
ZA POMOCĄ  
KABLA USB-C

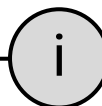

USB zawiera gumową  
zatkawkę chroniącą  
przed wilgocią

**IP44**

**W RAZIE PROBLEMÓW CZY PYTAŃ**

kom: 662 239 365

mail: [biuro@kaspacom.pl](mailto:biuro@kaspacom.pl)

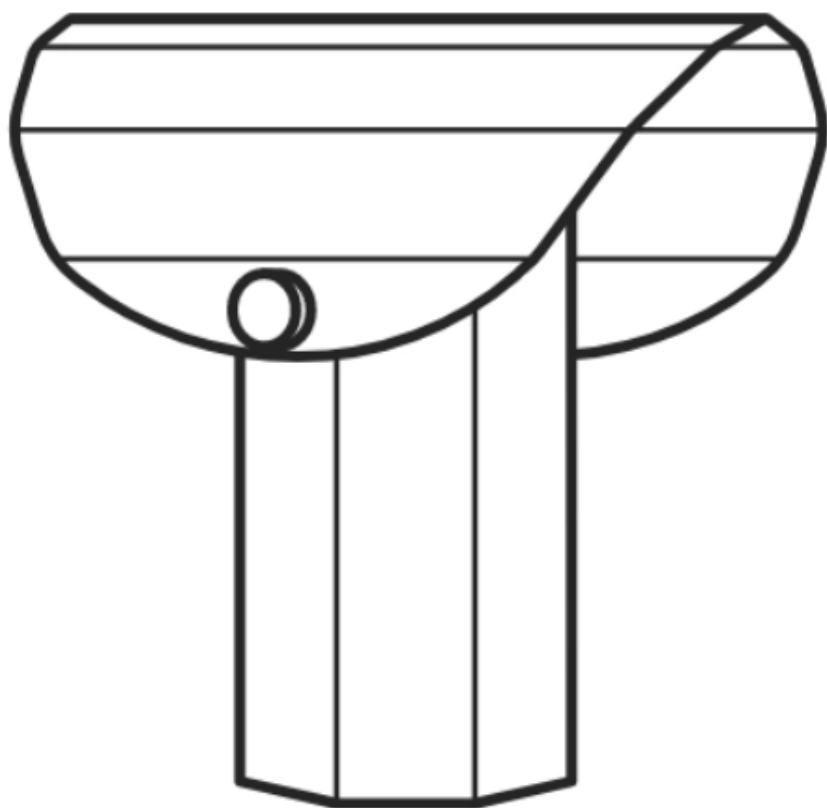

**k.**  
**KASPA**  
BY DESIGNERS

41234113

---

**APOLIN LAMPA  
PRZENOŚNA**

**INSTRUCTION**

---

**MANUAL**

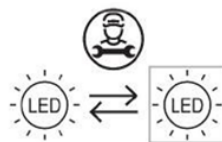

DIMMABLE

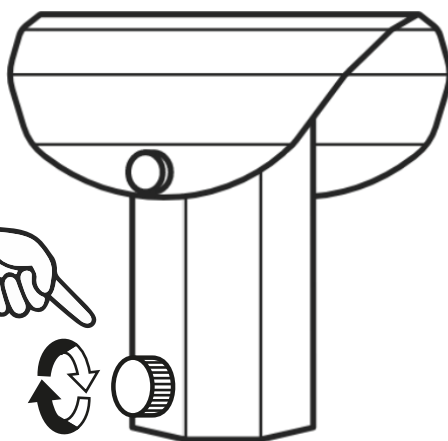
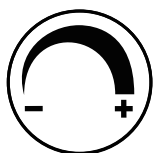

CHARGER  
NOT INCLUDED



CHARGING  
WITH A  
USB-C CABLE

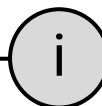
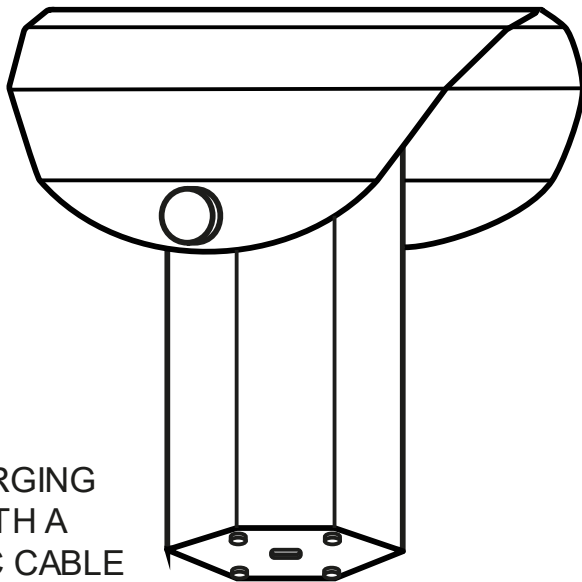

The USB includes a  
rubber cap to protect  
against moisture

**IP44**

**IN CASE OF PROBLEMS OR QUESTIONS**

mail: [biuro@kaspacom.pl](mailto:biuro@kaspacom.pl)