

k.
KASPA
BY DESIGNERS

41237104

**APOLIN LAMPA
PRZENOŚNA**

INSTRUKCJA

MONTAŻU I OBSŁUGI

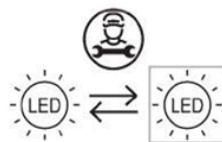

ZMIANA MOCY
ŚWIATŁA

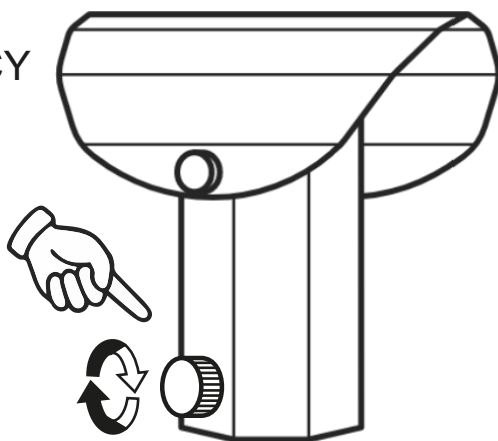
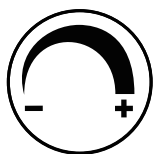

BRAK ŁADOWARKI
W ZESTAWIE



ŁADOWANIE
ZA POMOCĄ
KABLA USB-C

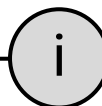

USB zawiera gumową
zatkawkę chroniącą
przed wilgocią

IP44

W RAZIE PROBLEMÓW CZY PYTAŃ

kom: 662 239 365

mail: biuro@kaspacom.pl

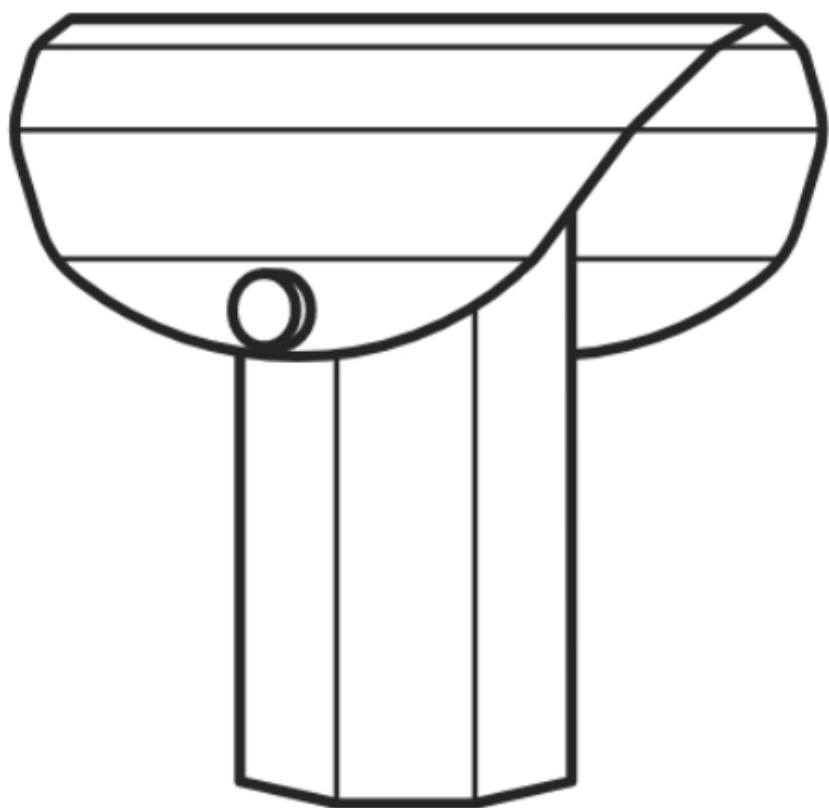

k.
KASPA
BY DESIGNERS

41237104

**APOLIN LAMPA
PRZENOŚNA**

INSTRUCTION

MANUAL

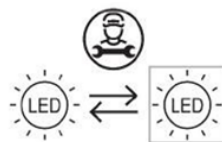

DIMMABLE

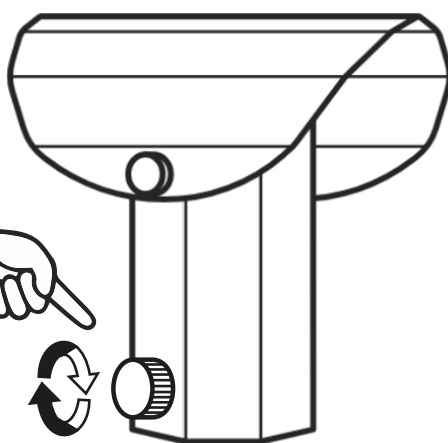
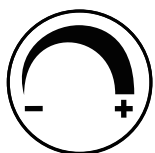

CHARGER
NOT INCLUDED

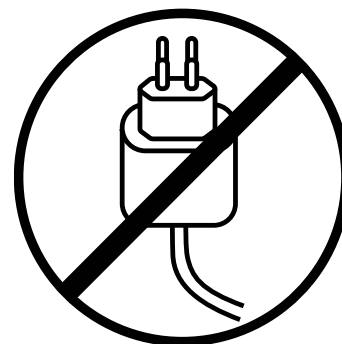

CHARGING
WITH A
USB-C CABLE

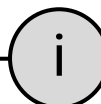
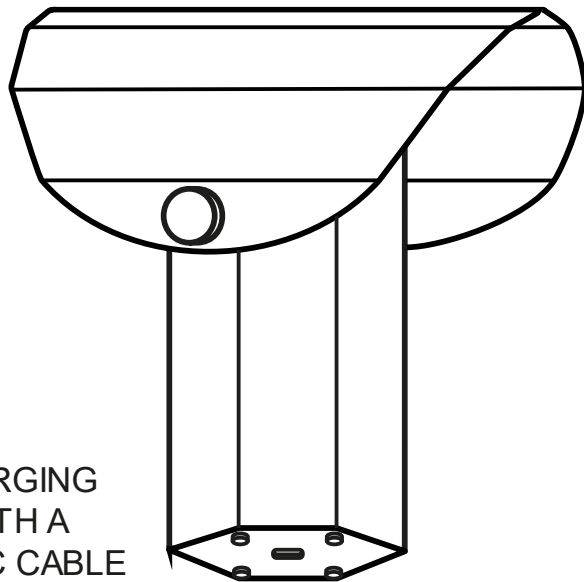

The USB includes a
rubber cap to protect
against moisture

IP44

IN CASE OF PROBLEMS OR QUESTIONS

mail: biuro@kaspacom.pl