

**k.**  
KASPA

70026102

---

BARLO 13

INSTRUKCJA

---

MONTAŻU I OBSŁUGI



## WAŻNE

Przed rozpoczęciem instalacji odłącz zasilanie. Pamiętaj, że instalacje elektryczne mogą być wykonywane wyłącznie przez wykwalifikowanych elektryków z uprawnieniami.

## PRZEZNACZENIE

Do montażu stacjonarnego jako lampa do wnętrza.



## POTRZEBNE NARZĘDZIA

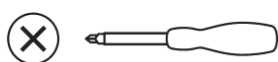

MAX 9W LED GU10



1 x

## UWAGA WAŻNE

Zawsze dobieraj wkręty i kołki odpowiednie dla Twoich sufitów/ścian (gipskarton, beton, cegła itd.). Wiertło, którego będziesz używać, powinno być dopasowane do średnicy kołka rozporowego (poprawnie odczytaj oznaczenie średnicy na trzonku wiertła). Do montażu lamp zaleca się używania kołków nie mniejszych niż  $\varnothing 8$ , przy lampach o dużym ciężarze stosuj kołki  $\varnothing 10$  i więcej.

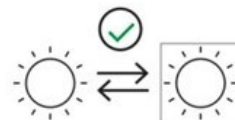
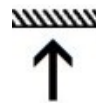

1



2

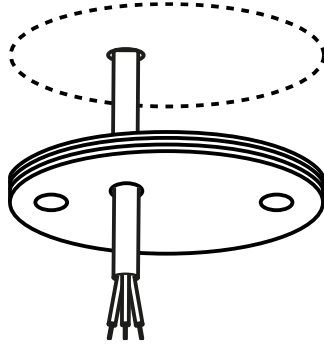

3

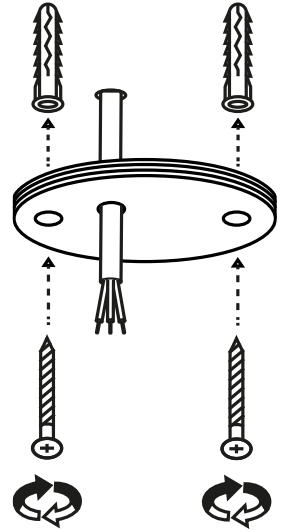

4

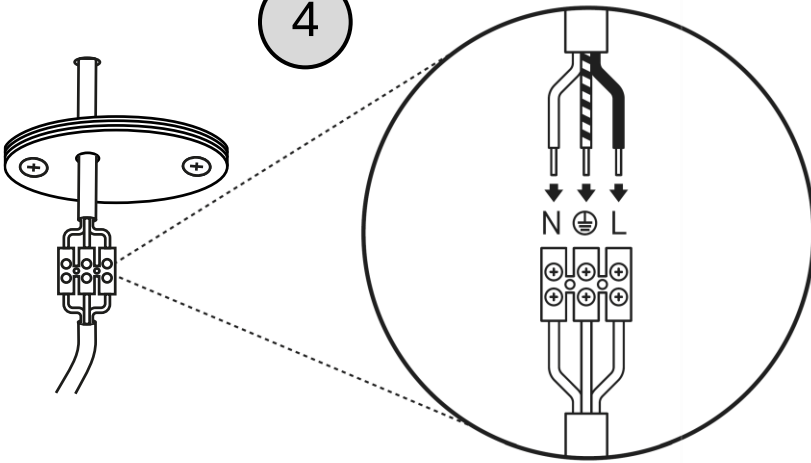

L – Przewód prądowy  
 ⊕ – Przewód uziemiający  
 N – Przewód zerowy

5

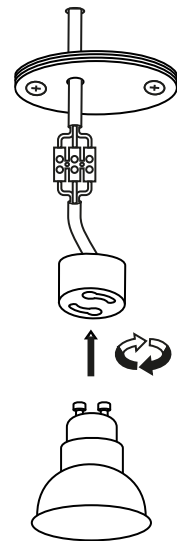

6

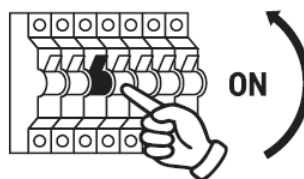
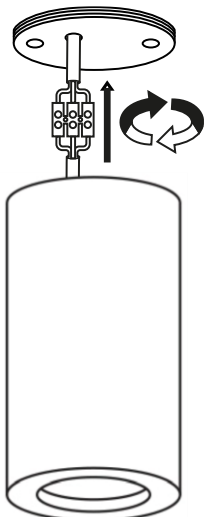

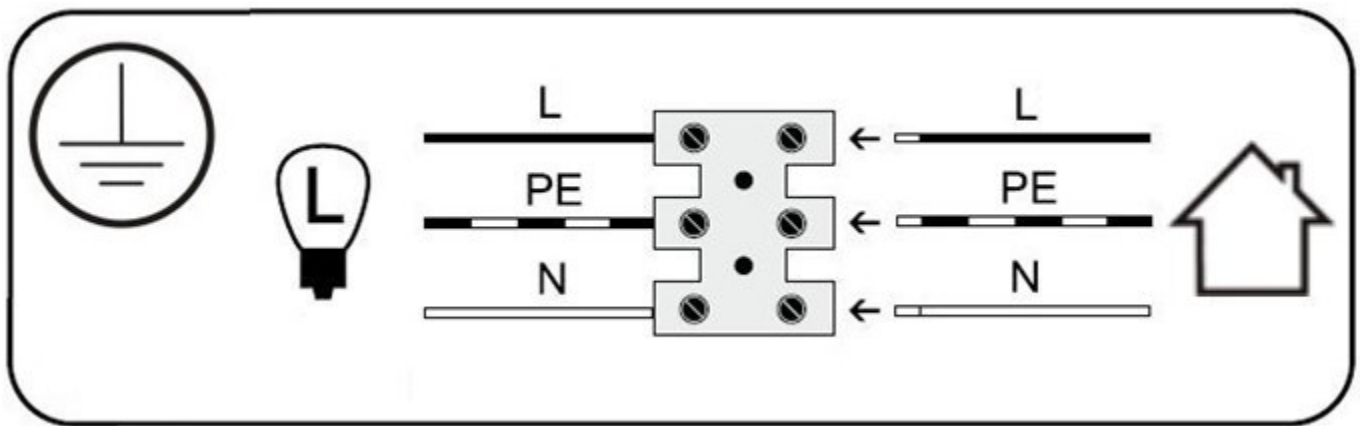

**L**

Przewód prądowy (faza) czarny



Klasa ochronna I Lampa z przewodem ochronnym.  
Przewód ochronny - symbol

**PE**

Przewód ochronny (żółto/zielony)



Symbol  
Podłączenie do sieci od strony lampy

**N**

Przewód zerowy (neutralny) niebieski



Symbol  
Podłączenie do sieci od strony domu

**W RAZIE PROBLEMÓW CZY PYTAŃ**

kom: 662 239 365

mail: [biuro@kaspacom.pl](mailto:biuro@kaspacom.pl)

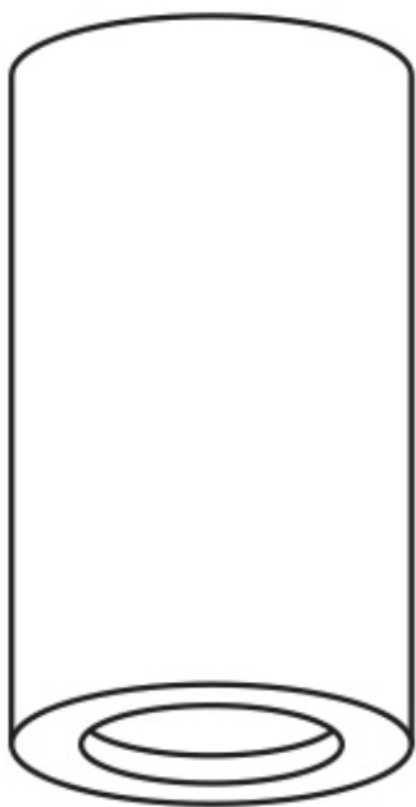

**k.**  
KASPA

70026102

---

BARLO 13

INSTRUCTION

---

MANUAL

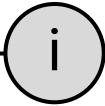

### TOOLS NEEDED

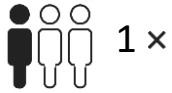
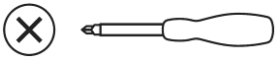
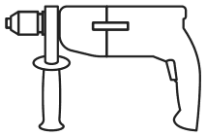

MAX 9W LED GU10

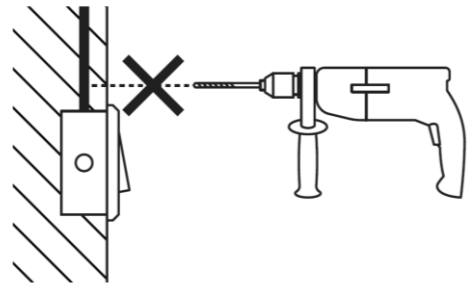
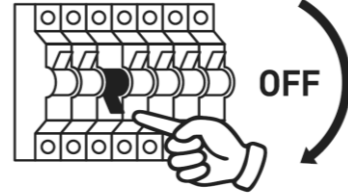
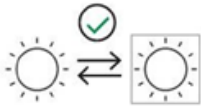
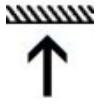

1



2

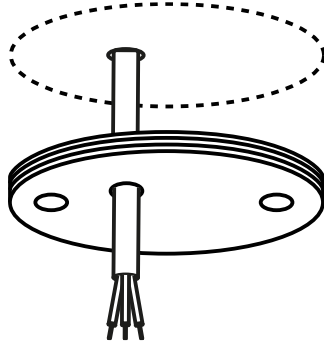

3

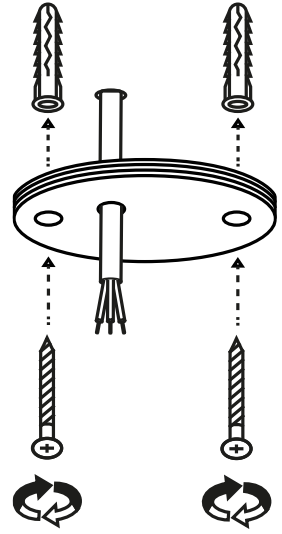

4

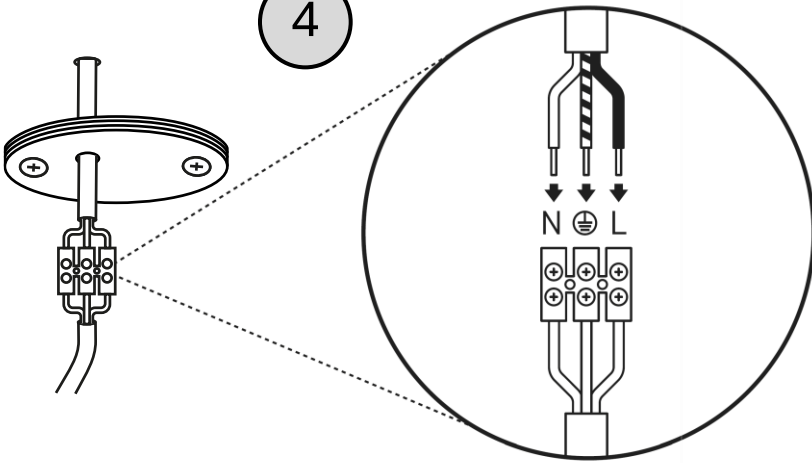

5

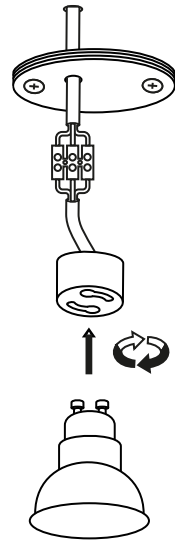

6

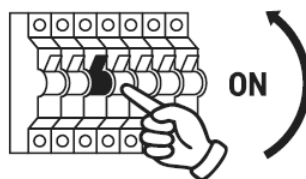
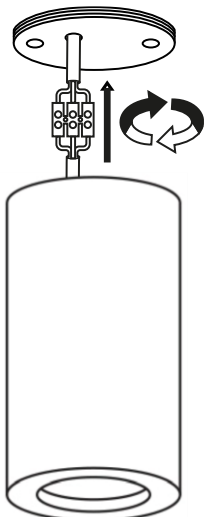

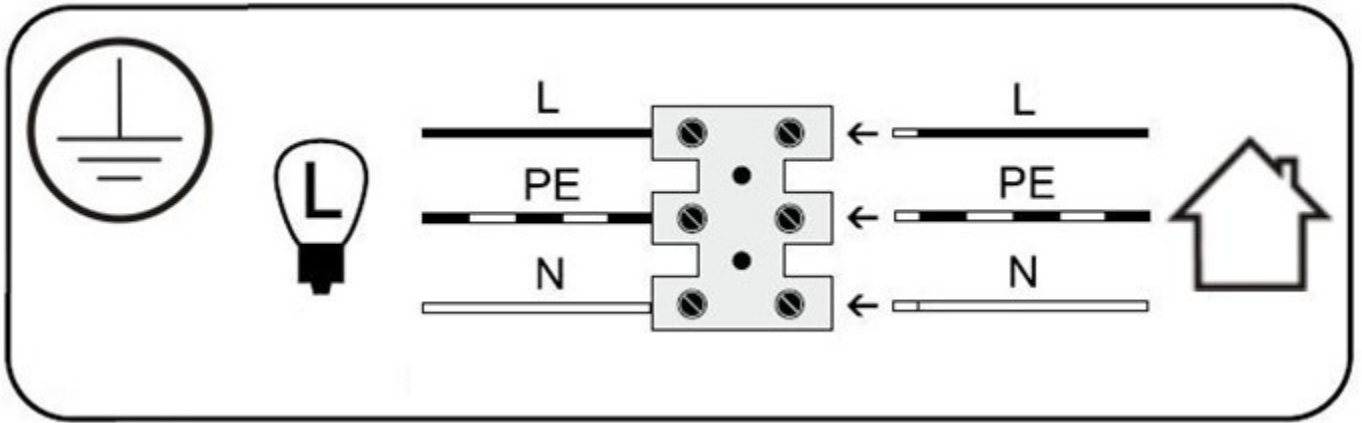

**L**

Power wire (phase) black



Protection class I Lamp with protective conductor - symbol

**PE**

Protective wire (yellow/green)



Symbol for mains connection on the lamp side

**N**

Neutral wire (blue)



Symbol for connection to the mains from the side of the house

**IN CASE OF PROBLEMS OR QUESTIONS**

mail: [biuro@kaspacom.pl](mailto:biuro@kaspacom.pl)